

机加工滚针轴承

D 10-27mm-NK7/12-TV1)

参数信息:

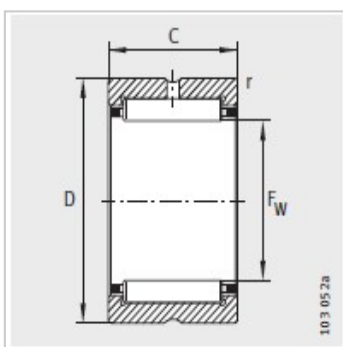
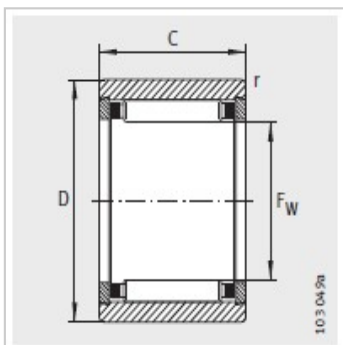

型号1 :	NK7/12-TV1)
型号2 :	-
型号3 :	-
X-life :	XL
质量m kg :	8.2

尺寸mm :

F :	7
D :	14
C :	12
r min :	0.3
静载荷 :	4150
动载荷 :	3600
疲劳极限载荷/N :	600
极限转速 :	34500
参考转速 :	42000

: