

机加工滚针轴承

D 10-27mm-NK6/10-TV1)

参数信息:

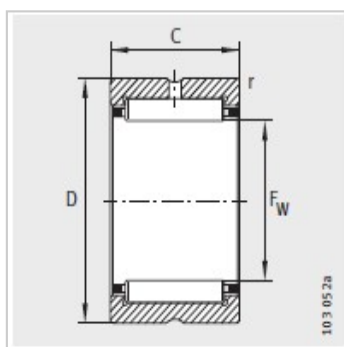
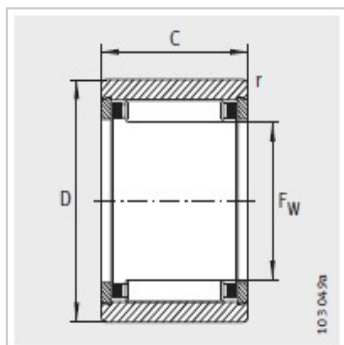

型号1 :	NK6/10-TV1 )
型号2 :	-
型号3 :	-
X-life :	XL
质量m kg :	4.7

尺寸mm :

F :	6
D :	12
C :	10
r min :	0.15
静载荷 :	2950
动载荷 :	2280
疲劳极限载荷/N :	355
极限转速 :	36500
参考转速 :	48500

: