

机加工滚针轴承

D 10-27mm-NK5/12-TV1)

参数信息:

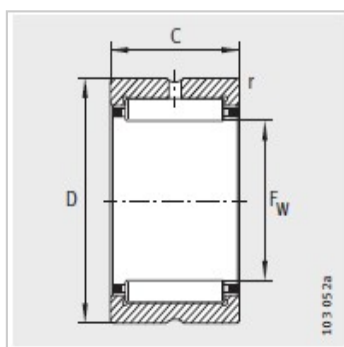
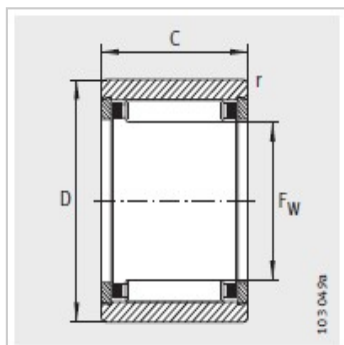

型号1 :	NK5/12-TV1)
型号2 :	-
型号3 :	-
X-life :	XL
质量m kg :	3.7

尺寸mm :

F :	5
D :	10
C :	12
r min :	0.15
静载荷 :	3400
动载荷 :	2650
疲劳极限载荷/N :	435
极限转速 :	39000
参考转速 :	54000

: