

机加工滚针轴承

D 10-27mm-NK10/12-TV1)

参数信息:

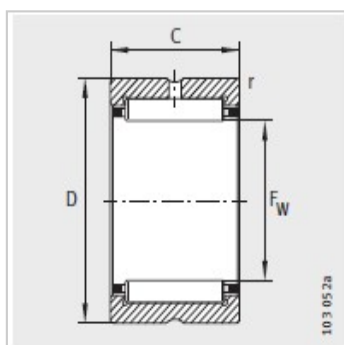
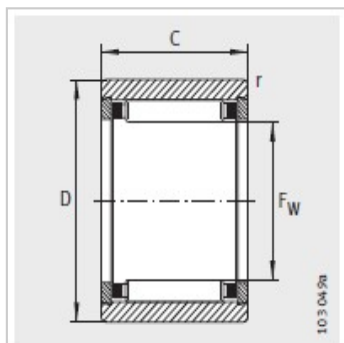

型号1 :	NK10/12-TV 1)
型号2 :	-
型号3 :	-
X-life :	XL
质量m kg :	10.1

尺寸mm :

F :	10
D :	17
C :	12
r min :	0.3
静载荷 :	5300
动载荷 :	5500
疲劳极限载荷/N :	930
极限转速 :	29500
参考转速 :	29000

: